



Test Report issued under the responsibility of:



IEC 60601-1
Medical electrical equipment
Part 1: General requirements for basic safety and essential performance

Report Reference No.: E146893-D1018-1/A0/C0-ULCB

Date of issue: 2018-3-7

Total number of pages: 165

CB Testing Laboratory: UL Fremont

Address: 47173 Benicia St., Fremont, CA 94538-7366, USA

Applicant's name: XP POWER LLC

Address: 15641 RED HILL AVE, SUITE 100
TUSTIN, CA, 92780 USA

Test specification:

Standard: IEC 60601-1:2005 (Third Edition) + CORR. 1:2006 + CORR. 2:2007
+ A1:2012
(or IEC 60601-1: 2012 reprint)

Test procedure: CB Scheme

Non-standard test method.....: N/A

Test Report Form No.....: IEC60601_1K

Test Report Form Originator: UL(US)

Master TRF: 2015-11

Copyright © 2015 Worldwide System for Conformity Testing and Certification of Electrotechnical Equipment and Components (IECEE), Geneva, Switzerland. All rights reserved.



This publication may be reproduced in whole or in part for non-commercial purposes as long as the IECEE is acknowledged as copyright owner and source of the material. IECEE takes no responsibility for and will not assume liability for damages resulting from the reader's interpretation of the reproduced material due to its placement and context.



This report is not valid as a CB Test Report unless signed by an approved CB Testing Laboratory and appended to a CB Test Certificate issued by an NCB in accordance with IECEE 02.

General disclaimer:

The test results presented in this report relate only to the object tested.

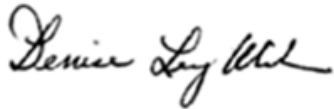
This report shall not be reproduced, except in full, without the written approval of the Issuing CB testing laboratory. The authenticity of this Test Report and its contents can be verified by contacting the NCB, responsible for this Test Report.

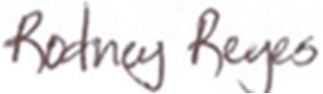
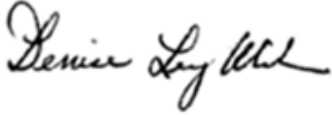
Test item description:	Power Supply for building-in, switch mode type	
Trade Mark:	Trademark image(s): 	
Manufacturer:	Same as Applicant	
Model/Type reference:	SMP350PSxx (where xx can be any number between 12 and 48 may also be provided with additional suffix "SF")	
Ratings:	Input: 100-240Vac, 50/60Hz, 4.9A See Model Differences Section for output ratings.	
Testing procedure and testing location:		
<input checked="" type="checkbox"/> CB Testing Laboratory:		
Testing location/ address:	UL Fremont 47173 Benicia St., Fremont, CA 94538-7366, USA	
<input type="checkbox"/> Associated CB Testing Laboratory:		
Testing location/ address:		
Tested by (name, function, signature):	Anthony Moussa/Project Handler	
Approved by (name, function, signature):	Denise Klinker/Project Reviewer	
<input type="checkbox"/> Testing procedure: CTF Stage 1:		
Testing location/ address:		
Tested by (name, function, signature):		
Approved by (name, function, signature):		
<input type="checkbox"/> Testing procedure: CTF Stage 2		
Testing location/ address:		
Tested by (name, function, signature):		
Witnessed by (name, function, signature):		
Approved by (name, function, signature):		

<input checked="" type="checkbox"/> Testing procedure: CTF Stage 3:	
<input type="checkbox"/> Testing procedure: CTF Stage 4:	
Testing location/ address:	XP POWER LLC 15641 RED HILL AVE, SUITE 100 TUSTIN, CA, 92780
Tested by (name, function, signature):	Rodney Reyes/tester 
Witnessed by (name, function, signature):	
Approved by (name, function, signature):	Denise Klinker/project reviewer 
Supervised by (name, function, signature):	Anthony Moussa/project handler 

List of Attachments (including a total number of pages in each attachment):

Refer to Appendix A of this report. All attachments are included within this report.

Summary of testing

Tests performed (name of test and test clause):

Testing location:

Refer to the Test List in Appendix D of this report if testing was performed as part of this evaluation.

Summary of compliance with National Differences

List of countries addressed: Austria, Korea, Republic of, USA, Canada, United Kingdom, Sweden

[X] The product fulfils the requirements of IEC 60601-1:2005 (Third Edition) + CORR. 1:2006 + CORR. 2:2007 + A1:2012

(or IEC 60601-1: 2012 reprint).

Copy of marking plate

The artwork below may be only a draft. The use of certification marks on a product must be authorized by the respective NCBs that own these marks.

Refer to the enclosure(s) titled Marking Label in the Enclosures section in Appendix A of this report for a copy.

GENERAL INFORMATION	
Test item particulars (see also Clause 6):	
Classification of Installation and Use:	Build-in
Device type (component/sub-assembly/ equipment/ system):	Component
Intended use (Including type of patient, application location):	The model covered in this report is a Class I build-in component power supply intended for use in Class I Medical Equipment.
Mode of Operation:	Continuous
Supply Connection:	Build-in
Accessories and detachable parts included:	N/A
Other Options Include:	N/A
Testing	
Date of receipt of test item(s)	2017-01-13, 2017-11-01
Dates tests performed	2017-01-17 to 2018-03-06
Possible test case verdicts:	
- test case does not apply to the test object	N/A
- test object does meet the requirement.....	Pass (P)
- test object was not evaluated for the requirement	N/E
- test object does not meet the requirement.....	Fail (F)
Abbreviations used in the report:	
- normal condition: N.C.	- single fault condition: S.F.C.
- means of Operator protection: MOOP	- means of Patient protection: MOPP
General remarks:	
Before starting to use the TRF please read carefully the 4 instructions pages at the end of the report on how to complete the new version "J" of TRF for IEC for 60601-1 3rd edition with Amendment 1.	
"(See Attachment #)" refers to additional information appended to the report.	
"(See appended table)" refers to a table appended to the report.	
The tests results presented in this report relate only to the object tested.	
This report shall not be reproduced except in full without the written approval of the testing laboratory.	
List of test equipment must be kept on file and available for review.	
Additional test data and/or information provided in the attachments to this report.	
Throughout this report a point is used as the decimal separator.	
Manufacturer's Declaration per sub-clause 4.2.5 of IEC 60601-1:2012	
The application for obtaining a CB Test Certificate includes more than one factory location and a declaration from the Manufacturer stating that the sample(s) submitted for evaluation is (are) representative of the products from each factory has been provided	Yes
When differences exist; they shall be identified in the General product information section.	

Name and address of factory (ies): XP POWER (VIETNAM) CO LTD
 LOT D - 4Q - CN MY PHUOC 3 INDUSTRIAL
 PARK
 BEN CAT DISTRICT BINH DUONG VIETNAM

XP POWER PLC
 HORSESHOE PARK PANGBOURNE
 RG87 JW UNITED KINGDOM

XP POWER (KUNSHAN) LTD
 230, BIN JIANG NAN ROAD
 ZHANG PU TOWN KUNSHAN, JIANGSU 215300
 CHINA

XP POWER LLC
 990 BENECIA AVENUE
 SUNNYVALE, CA 94085 USA

GENERAL PRODUCT INFORMATION:

Report Summary

All applicable tests according to the referenced standard(s) have been carried out.
 Refer to the Report Modifications for any modifications made to this report.

Product Description

The model covered in this report is a Class I build-in component power supply intended for use in Class I Medical Equipment.

The Marking Plate is representative of all models.

Model Differences

All models in the Model SMP350PSXX series are identical with exception to model designation, Transformer (T1) and secondary components/circuitry that allow for different output voltage ratings.

Model output ratings as follows.

Model SMP350PS12: Output Rated: 10.1 Vdc - 13.5 Vdc, 25 A Max., 300 W Max.

Model SMP350PS15: Output Rated: 13.6 Vdc - 17 Vdc, 22 A Max., 330 W Max.

Model SMP350PS18: Output Rated: 17.1 Vdc - 21 Vdc, 19.4 A Max, 350 W Max.

Model SMP350PS24: Output Rated: 21.1 Vdc - 26 Vdc, 14.6 A Max., 350 W Max.

Model SMP350PS28: Output Rated: 26.1 Vdc - 31 Vdc, 12.5 A Max., 350 W Max.

Model SMP350PS33: Output Rated: 31.1 Vdc - 33 Vdc, 10.6 A Max., 350 W Max.

Model SMP350PS36: Output Rated: 33.1 Vdc - 42 Vdc, 9.70 A Max, 350 W Max.

Model SMP350PS48: Output Rated: 42.1 Vdc - 54 Vdc, 7.30 A Max., 350 W Max.

Provided with additional suffix "SF" to indicate single pole fusing.

Additional Information

N/A

Technical Considerations

- The product was investigated to the following standards:

Main Standard(s):

ANSI/AAMI ES60601-1:2005/(R)2012 and A1:2012, C1:2009/(R)2012 and A2:2010/(R)2012,
CAN/CSA C22.2 No. 60601-1:14, IEC 60601-1 :2005 +A1 :2012

From Country Differences:

- Austria: EN 60601-1:2006/A1:2013
- Korea, Republic of: KS C IEC 60601-1
- USA: ANSI/AAMI ES60601-1: A1:2012, C1:2009/(R)2012 and A2:2010/(R)2012
- Canada: CSA CAN/CSA-C22.2 NO. 60601-1:14
- United Kingdom: BS EN 60601:2006 A1
- Sweden: SS-EN 60601-1:2006+A11:2011+A1:2013+AC1:2014+A12:2014

Additional Standards:

EN 60601-1:2006 / A1:2013 / A12:2014

- The following additional investigations were conducted: N/A
- The product was not investigated to the following standards or clauses: Clause 9, 10, 11, 12, 14, 16, Annex G
- The following accessories were investigated for use with the product: N/A
- No Other Considerations.

Engineering Conditions of Acceptability

When installed in an end-product, consideration must be given to the following:

- Considerations to the applied parts requirement, to be conducted as end-product
- The component shall be installed in compliance with the enclosure, mounting, marking, spacing, and separation requirements of the end use application.
- Legibility and Durability of Markings, Fixing of Mains Terminals, Temperature, Leakage Current, Protective Earthing, Dielectric Voltage Withstand, and Interruption of the Power Supply tests should be considered as part of the end product evaluation.
- The following clauses are to be determined as part of the end product evaluation: Clause 7.5 (Safety Signs), Clause 7.9 (Accompanying Documents), Clause 8 (Electrical Hazard) Clause 9 (ME Hazard), Clause 10 (Radiation), Clause 11 (Temperature), Clause 12 (Controls), Clause 13 (SFC/Abnormals), Clause 14 (PEMS), Clause 15, Clause 16 (ME Systems)
- Consideration should be given to measuring the temperature on power electronic components and transformer windings when the power supply is installed in the end-use equipment. The end-use product shall ensure that the power supply is used within its ratings.
- Power supply provides the following MOPP (means of patient protection): 2 MOPP based upon a working voltage 240 Vrms, 340 Vpk between Primary to Secondary, 1 MOPP based upon a working voltage 240 Vrms, 340 Vpk between Primary and Earth/Enclosure, and 1 MOPP based upon a working voltage 48 Vrms between Secondary and Earth/Enclosure

Report Modifications

Date Modified (Year-Month-Day)	Modifications Made (include Report Reference Number)	Modified By



IEC 60601-1

Clause	Requirement + Test	Result - Remark	Verdict
--------	--------------------	-----------------	---------

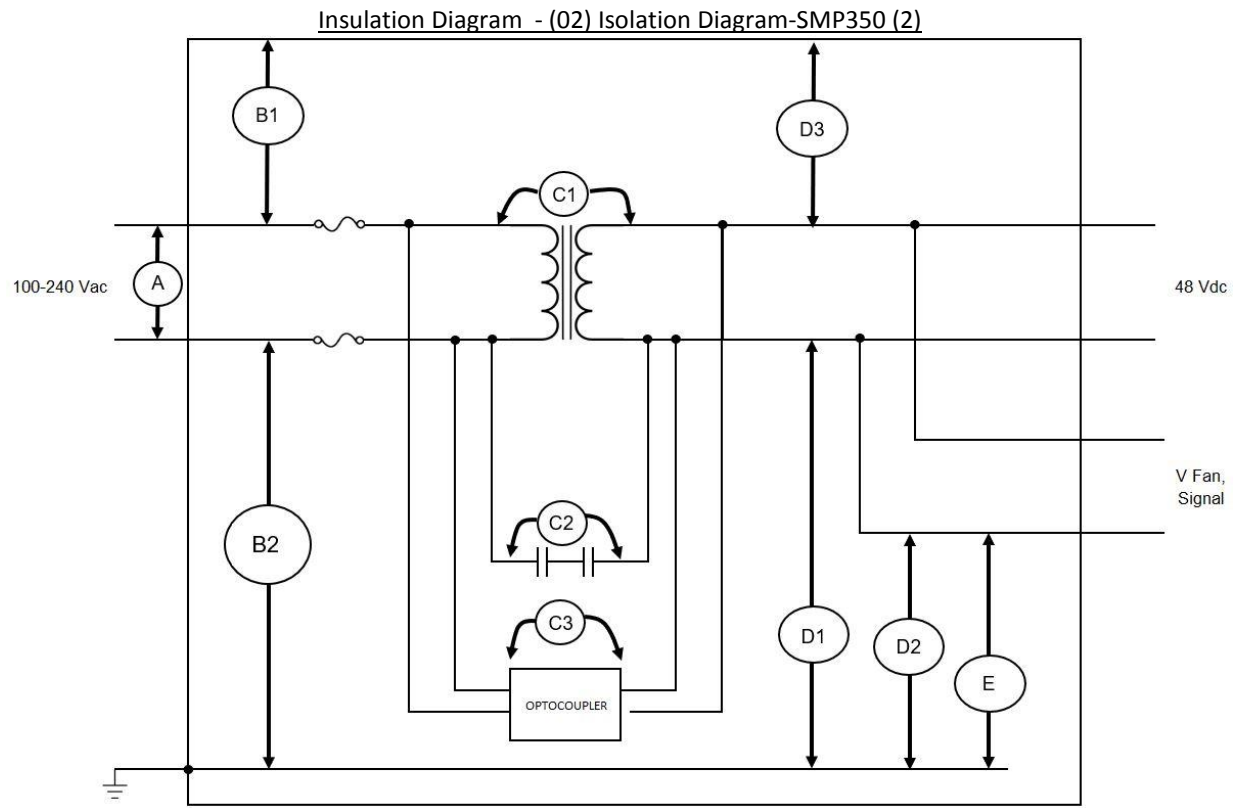

TABLE: INSULATION DIAGRAM									Pass	
Pollution Degree:		2								-
Overtoltage category:		II								-
Altitude:		5000 (m)								-
Additional details on parts considered as applied parts:		[X] None [] Areas: ____ (See Clause 4.6 for details)								-
Area	Number and type of Means of Protection: MOOP, MOPP	CTI	Working Voltage V_{rms}	Working Voltage V_{pk}	Required creepage (mm)	Required clearance (mm)	Measured creepage (mm)	Measured clearance (mm)	Remarks	
A	MOOP (1)	IIIb	240	340	2.96	2.96 (2 x 1.48)	4.9	4.9	Between Line and Neutral of TB1	
B1	MOPP (1)	IIIb	240	340	4	3.23 (2.5 x 1.29)	4.9	4.9	Class I configuration: Between Mains and Earth ground (metal chassis)	
B2	MOPP (1)	IIIb	240	340	4	3.23 (2.5 x 1.29)	8	8	Measured between Y-Cap (C45) to ground	
B2	MOPP (2)	IIIb	240	340	8	6.45 (5 x 1.29)	8.5	8.5	Measured between Y-Caps (C2) and ground	

IEC 60601-1									
Clause	Requirement + Test					Result - Remark			Verdict
C1	MOPP (2)	IIIb	240	340	8	6.45 (5 x 1.29)	-	-	Spacing within transformer (T1); employs triple insulated wire complying with Annex L
C1	MOPP (2)	IIIb	240	340	8	6.45 (5 x 1.29)	8.23	8.23	Between primary and secondary side of PWB (measured under T1)
C2	MOPP (2)	IIIb	240	340	8	6.45 (5 x 1.29)	19.9	19.9	Across bridging cap (C20, C21)
C3	MOPP (2)	IIIb	240	340	8	6.45 (5 x 1.29)	9	9	Across optoisolators
D1, D3	MOPP (1)	IIIb		48	2.3	1.548 (1.2 x 1.29)	6.75	6.75	Between secondary and grounding of chassis.
D2	MOPP (1)	IIIb		48	2.3	1.548 (1.2 x 1.29)	4.9	4.9	Measured between connector J4 to ground
E	MOPP (1)	IIIb		48	2.3	1.548 (1.2 x 1.29)	13.38	13.38	Measured between J3 and ground

Supplementary Information:

INSULATION DIAGRAM CONVENTIONS and GUIDANCE:

A measured value must be provided in the value columns for the device under evaluation. The symbol > (greater than sign) must not be used. Switch-mode power supplies must be re-evaluated in the device under evaluation therefore N/A must not be used with a generic statement that the component is certified. Insulation diagram is a graphical representation of equipment insulation barriers, protective impedance and protective earthing. If feasible, use the following conventions to generate the diagram:

- All isolation barriers are identified by letters between separate parts of diagram, for example separate transformer windings, optocouplers, wire insulation, creepage and clearance distances.
- Parts connected to earth with large dots are protectively earthed. Other connections to earth are functional
- Applied parts are extended beyond the equipment enclosure and terminated with an arrow.
- Parts accessible to the operator only are extended outside of the enclosure, but are not terminated with an arrow.