

## 150W BASEPLATE COOLED

DC-DC CONVERTER

The RDF150 Series is a range of low profile, baseplate cooled DC-DC brick converters that delivers 150W and offers single output voltages ranging from 5V to 48VDC. The RDF150 series offers an ultra-wide 12:1 input range of 14 to 160VDC, which covers standard industrial voltages and meets all requirements of the EN50155 transportation standard. Baseplate cooling enables effective thermal management which ensures elevated levels of reliability.

With world-wide industrial safety approvals and compliance to transportation standards, high efficiency, high reliability, 3kVAC reinforced isolation, remote On/Off and wide output trimming, the RDF150 series benefits system designers with easy integration into a wide range of applications including; renewable energy, battery systems, autonomous equipment, factory automation and harsh environment railway applications.



### Features

- Single voltage outputs from 5V to 48VDC
- Wide output voltage trim and remote sense
- 12:1 ultra-wide input range 14 to 160VDC
- Industry standard half brick format
- High efficiency, up to 90%
- 3kVAC reinforced input to output isolation
- ITE safety approvals and EN50155 compliance
- Remote On/Off with low 15mA stand-by current
- -40°C to +100°C operating case temperature
- Overvoltage, overload, and short circuit protection

### Models & Ratings

Model Number	Input Voltage	Output Voltage	Output Current	Input Current <sup>(6)</sup>		Ripple & Noise <sup>(1)</sup>	Maximum Capacitive Load	Efficiency <sup>(2)</sup>
				No Load	Full Load			
RDF15072S05	72VDC (14-160VDC)	5V	25.0A	50mA (15mA in inhibit mode)	1.93A	150mV	25000µF	89%
RDF15072S12		12V	12.5A		2.29A	200mV	16700µF	90%
RDF15072S15		15V	10.0A		2.32A	200mV	10000µF	89%
RDF15072S24		24V	6.25A		2.34A	240mV	6250µF	89%
RDF15072S48		48V	3.2A		2.37A	240mV	2200µF	90%

#### Notes:

1. Measured at 20MHz bandwidth and 1µF ceramic and 10µF tantalum capacitors (for 48V, 10µF electrolytic and 0.1µF ceramic capacitor) at 72VDC input and full load.
2. Measured at nominal 72VDC input.
3. Optional M3 x 0.5 threaded baseplate fixing add suffix -T.

4. Recommended input capacitance of 100µF required to reduce input ripple voltage at -40°C operation. See application notes.
5. Add suffix -N for negative logic control.
6. Typical at 72VDC input.

### Applications



Factory Automation &  
Industrial Electronics



Railway

### Dimensions

61.0 x 57.9 x 12.7mm (2.40" x 2.28" x 0.50")

## Input

Characteristic	Minimum	Typical	Maximum	Units	Notes & Conditions
Input Voltage Range	14		160	VDC	24/48/72/110VDC nominal inputs. Derate output power to 65% with input below 16.5VDC
Input Surge			180	VDC	For 100ms
Undervoltage Lockout		>12.5		VDC	On
		<11.5			Off
Lockout Hysteresis		2		VDC	
Idle Current		15		mA	When output is inhibited
Inrush Current			0.1	A <sup>2</sup> s	Reference to ETS300 132-2
Input Reflected Ripple Current		50		mA pk-pk	Through 12μH inductor, 5Hz to 20MHz at nominal input
Recommended Input Fuse	T18A				
Input Filter	Pi type				

## Output

Characteristic	Minimum	Typical	Maximum	Units	Notes & Conditions
Output Voltage	5		48	VDC	See Models & Ratings
Output Trim	-20		+15	%	See Application Note
Initial Set Accuracy			±1.0	%	At full load and 72VDC nominal input
Minimum Load	No minimum load required				
Line Regulation			±0.2	%	From minimum to maximum input at full load
Load Regulation			±0.2	%	From 0% to full load
Transient Response			±5.0	%	Maximum deviation, recovering to less than 1% in 250μs for 25% step load change
Start Up Delay		100		ms	
Output Voltage Rise Time		100		ms	
Ripple & Noise				mV pk-pk	See Models & Ratings
Overload Protection	110	125	140	%	Vout <90%
Short Circuit Protection	Continuous hiccup mode, with autorecovery				
Maximum Capacitive Load	See Models & Ratings table				
Temperature Coefficient			±0.02	%/°C	Tc -40°C to +100°C
Overvoltage Protection	115	125	140	%	Of nominal output voltage
Remote On/Off	Output is on if remote On/Off (pin 4) is open or high (3.5-160VDC), positive logic. Output turns off if remote On/Off (pin 4) is low (0-1.2VDC max.) Positive logic default, for negative logic option add -N suffix to part number. On/Off current typ. 0.3mA to max 1mA				

## General

Characteristic	Minimum	Typical	Maximum	Units	Notes & Conditions
Efficiency		90		%	See Models & Ratings table
Isolation: Input to Output	3000			VAC	60s, reinforced
Isolation: Input to Case	3000			VAC	60s, basic
Isolation: Output to Case	500			VAC	60s, basic
Isolation Resistance	10 <sup>8</sup>			Ω	
Isolation Capacitance		500		pF	Input to output
Switching Frequency	432	480	528	kHz	Fixed. Sync pin option
Power Density		139.7		Wcm <sup>3</sup>	
Mean Time Between Failure	450			khrs	MIL-HDBK-217F, +25°C GB
Weight		105.0 (0.23)		g (lb)	
Case Material	Plastic DAP (UL94V-0) with aluminium base plate				
Potting Material	Epoxy UL94V-0				
Pin Material	Copper with nickel and matte tin plate				
Fire and Smoke	Meets EN45545-2				
Solder Profile	Wave solder 260°C max, 10s max, 1.5mm from case. With 90W iron, 420°C for max. 15s				
Water Washing	Use de-ionised water, dry thoroughly				

## Environmental

Characteristic	Minimum	Typical	Maximum	Units	Notes & Conditions
Operating Base Plate	-40		+100	°C	
Storage Temperature	-55		+125	°C	
Thermal Protection		+105		°C	Measured on base plate, non latching. Recover <95°C
Humidity			95	%RH	Non-condensing
Cooling	Baseplate cooled				
Altitude			5000	m	Operating. Storage 12000m
Shock & Vibration	Meets EN61373/MIL-STD-810F				

## EMC: Emissions

Phenomenon	Standard	Test Level	Notes & Conditions
Conducted	EN50121-3-2	A	See Application Notes
Radiated	EN50121-3-2		See Application Notes

## EMC: Immunity

Phenomenon	Standard	Test Level	Criteria	Notes & Conditions
Railway Equipment	EN50121-3-2			See Application Notes
ESD Immunity	EN61000-4-2	±6kV/±8kV	A	Contact Discharge/Air Discharge
Radiated Immunity	EN61000-4-3	20V/m	A	
EFT/Burst	EN61000-4-4	2kV	A	External component required, see Application Notes
Surge	EN61000-4-5	±4kV/±2kV	A	External component required, see Application Notes
Conducted immunity	EN61000-4-6	10Vrms	A	

## Safety Approvals

Safety Agency	Standard	Test Level	Notes & Conditions
UL	62368-1		ITE
EN	50155		Railway
CE	Meets all applicable directives		
UKCA	Meets all applicable legislation		

## Application Notes

### Input Fusing and Safety Considerations

The RDF150 series converters have no internal fuse. In order to achieve maximum safety and system protection, always use an input line fuse. We recommended a 18A time delay fuse. It is recommended that the circuit has a transient voltage suppressor diode (TVS) across the input terminals to protect the unit against surge or spike voltages and input reverse voltage (as shown). A suitable part would be 1.5 KE180 A Littlefuse.

### Output Voltage Adjustment

The trim input permits the user to adjust the output voltage up by 15% or down by 20%. This is accomplished by connecting an external resistor between the Trim pin and either the +Sense pin or the -Sense pin. Alternatively, with a 10kΩ variable resistor.

### To Trim Down

Connecting an external resistor (R<sub>d</sub>) between the Trim pin and the +Sense pin decreases the output voltage. The following table can be used to determine the required external resistor value to obtain a percentage output voltage change of Δ%.

Trim Down %	5V	12V	15V	24V	48V
	R <sub>d</sub> (kΩ)				
1	387.8	389.7	573.8	929.5	1715.6
2	186.7	186.4	276.3	447.2	821.8
3	119.7	118.7	177.2	286.5	523.9
4	86.1	84.8	127.6	206.1	374.9
5	66.0	64.5	97.8	157.9	285.6
6	52.6	50.9	78.0	125.7	226.0
7	43.0	41.3	63.9	102.8	183.5
8	35.9	34.0	53.3	85.6	151.5
9	30.3	28.4	45.0	72.2	126.7
10	25.8	23.8	38.4	64.5	106.8
11	22.2	20.1	33.0	52.7	90.6
12	19.1	17.0	27.5	45.4	77.0
13	16.5	14.5	24.7	39.2	65.6
14	14.3	12.2	21.4	33.9	55.8
15	12.4	10.3	18.6	29.3	47.2
16	10.7	8.6	16.0	25.3	39.8
17	9.3	7.1	13.9	21.7	33.2
18	7.9	5.8	11.9	18.6	27.4
19	6.8	4.6	10.2	15.8	22.2
20	5.7	3.5	8.6	13.2	17.48

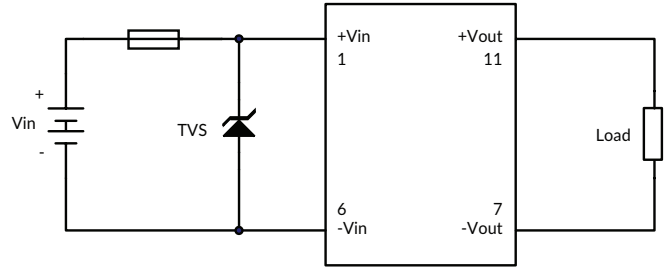

### Output Voltage Sensing

The module will automatically trim the output voltage via the sense pins to the default values either locally or at the load. If not required, the sense pins should be connected locally as indicated in the example hold up circuit.

### To Trim Up

Connecting an external resistor (R<sub>u</sub>) between the Trim pin and the -Sense pin increases the output voltage. The following table can be used to determine the required external resistor value to obtain a percentage output voltage change of Δ%.

Trim Up %	5V	12V	15V	24V	48V
	R <sub>u</sub> (kΩ)				
1	210.4	263.2	302.5	515.6	1040.5
2	101.1	126.6	145.2	247.8	498.7
3	64.7	81.0	92.8	158.5	318.0
4	46.5	58.2	66.6	113.9	227.7
5	35.5	44.6	50.9	87.1	173.5
6	28.2	35.5	40.4	69.3	137.4
7	23.0	29.0	33.0	55.5	111.6
8	19.1	24.1	27.3	46.9	92.3
9	16.1	20.3	22.9	39.5	77.2
10	13.7	17.3	19.4	33.5	65.2
11	11.7	14.8	16.6	28.7	55.3
12	10.0	12.7	14.2	24.6	47.1
13	8.6	11.0	12.2	21.2	40.1
14	7.4	9.5	10.5	18.2	34.2
15	6.4	8.2	8.9	15.7	29.0

### Remote On/Off Control

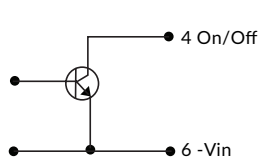

Positive logic: "On" if pin 4 is high >3.5V to 160VDC  
 "Off" if pin 4 is low <1.2V to 0VDC

### External Trim

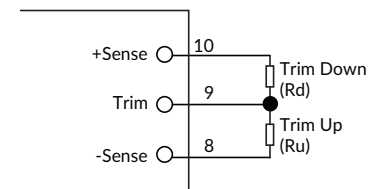
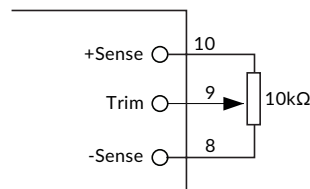

## Application Notes

### Hold Up

To enable hold up functionality the BUS pin can be used as outlined in the following typical circuit where C2 energy is used to maintain the module output.

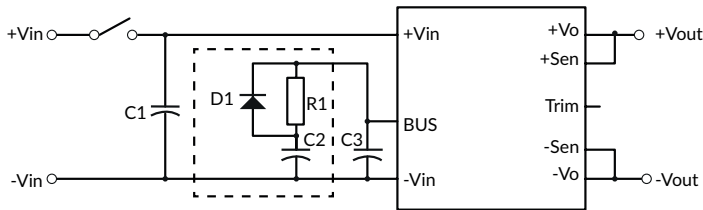

C2	Nominal Input Voltages					
	24V	36V	48V	72V	96V	110V
For 10ms	2400µF	2400µF	2400µF	2400µF	820µF	560µF
For 30ms	7200µF	7200µF	7200µF	7200µF	2460µF	1680µF

If the hold up function is not required use only C3

Suggested components:

C1 : 100µF 200V ESR <0.047Ω  
 C3 : 240µF (such as Vishay 118AHT)

D1 : 200V 10A  
 R1 : 3mΩ 1W

### Adjustable Under Voltage Lockout

The module has default under voltage lockout feature.

This can be adjusted by using the following typical circuit:

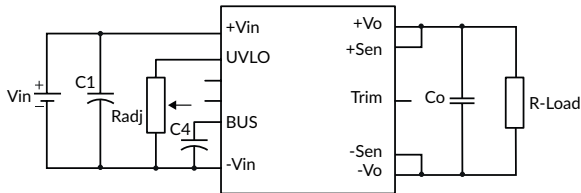

	Nominal Input Voltages				
	24V	36V	48V	72V	110V
Turn Off Threshold (VDC)	11.0 ±0.5	20.0 ±1.0	27.3 ±1.0	41.6 ±1.0	53.0 ±1.0
Turn Off Threshold (VDC)	13.0 ±0.5	22.0 ±1.0	29.6 ±1.0	44.6 ±1.0	58.0 ±1.0
Radj Resistor (KΩ) (UVLO to -Vin)	Open	62	34	18	10

Suggested components:

C1 : 100µF 200V ESR <0.047Ω  
 C3 : 240µF (such as Vishay 118AHT)

### Synchronized Frequency

An external clock can be used to synchronize the RDF150 by use of a narrow pulse (75ns-120ns, 3.5-5VDC) applied to pin 3 "Sync". The applied signal should be between 530kHz and 630kHz and above the RDF150 switching frequency. Connect applied pulse in parallel with a 5.6V Zener diode as shown.

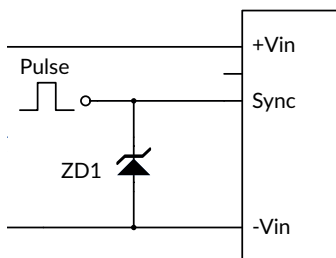

**Application Notes**

**Airflow Derating Graph (Without Heatsink)**

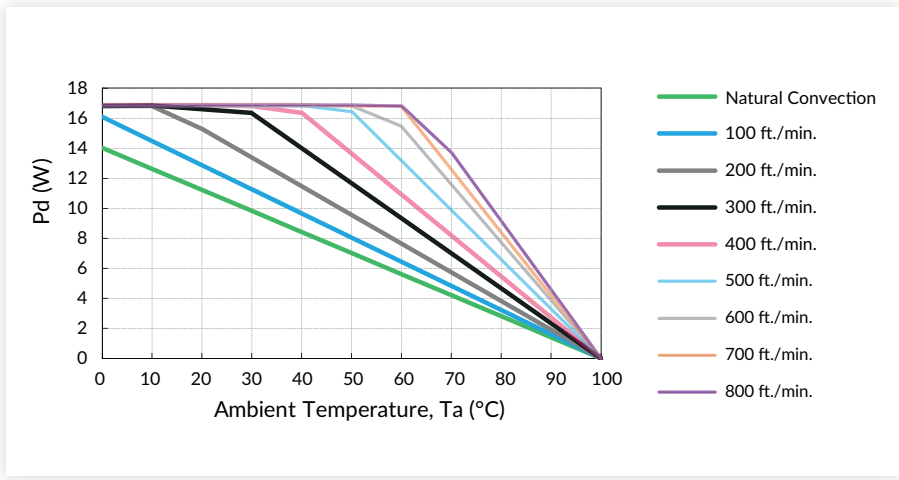

Air Flow Rate	Typical Rca
Natural Convection 20ft/min (0.1m/s)	7.12°C/W
100ft/min (0.5m/s)	6.21°C/W
200ft/min (1.0m/s)	5.17°C/W
300ft/min (1.5m/s)	4.29°C/W
400ft/min (2.0m/s)	3.64°C/W
500ft/min (2.5m/s)	2.96°C/W
600ft/min (2.5m/s)	2.53°C/W
700ft/min (2.5m/s)	2.37°C/W
800ft/min (2.5m/s)	2.19°C/W

**Example (Without Heatsink)**

To determine the minimum airflow necessary for a RDF15072WS24 operating at an input voltage of 72V, an output current of 6.25A, and a maximum ambient temperature of 20°C:

Determine Power dissipation (Pd):  $Pd = Pi - Po = Po(1-\eta)/\eta$ ,

$$Pd = 24V \times 6.25A \times (1-0.894)/0.894 = 17 \text{ Watts}$$

Where  $Pi$  = Input power,  $Po$  = Output Power and  $\eta$  = Efficiency

Determine airflow from airflow derating graph using data points for  $Pd=17W$  and  $Ta = 20^\circ C$

Minimum airflow= 400ft./min.

To check that the maximum case temp of 100°C is not exceeded:

Maximum temperature rise is  
 $\Delta T = Pd \times Rca = 17 \times 3.64 = 62.$   
 Maximum case temperature is  
 $Tc = Ta + \Delta T = 82^\circ C < 100^\circ C.$

Where: Rca is the thermal resistance from case to ambient environment. Ta is ambient temperature and Tc is case temperature.

**Solder Profile**

With iron 420 ±10°C for maximum 15s.

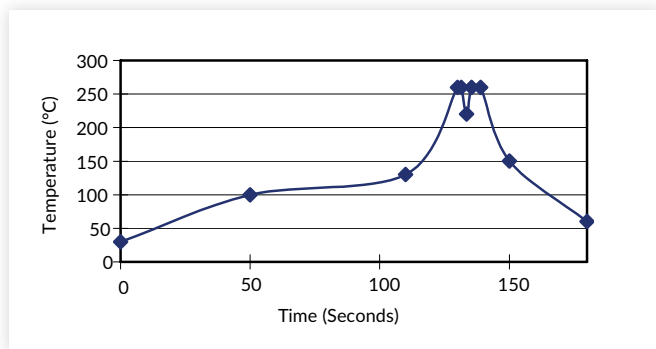

Application Notes

EMC Filter - Emissions and Immunity

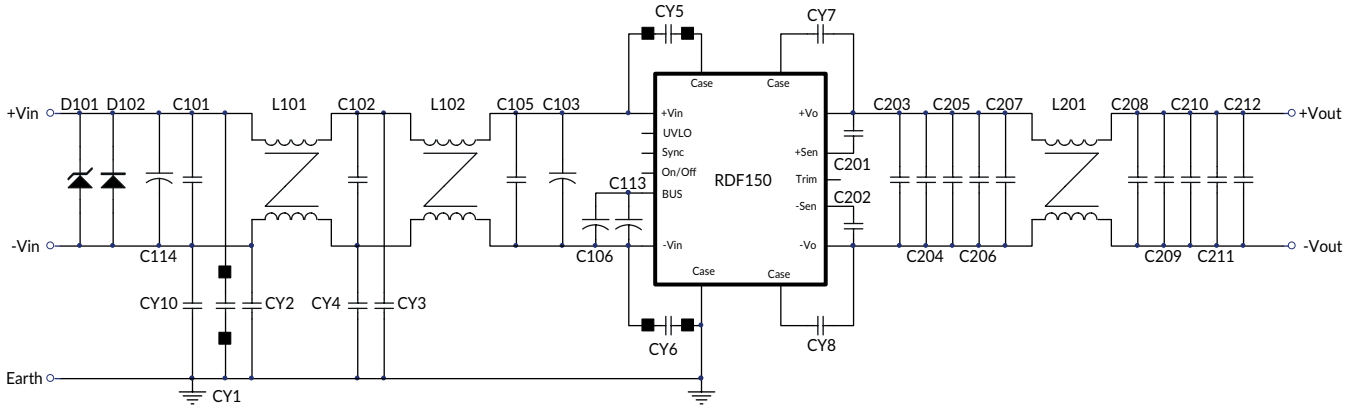

	RDF15072S05	RDF15072S12	RDF15072S15	RDF15072S24	RDF15072S48
C101, C102, C105			1µF/250V SMD		
C103, C113			220µF/200V aluminum cap. KXJ series		
C106			68µF/200V aluminum cap. CS series		
C114			120µF/220V aluminum cap. KXJ series		
C201, C202	0.1µF/100V SMD	0.068µF/50V SMD			0.1µF/100V SMD
C203~204			6.8µF/50V SMD		2.2µF/100V SMD
C205~C207			10µF/50V SMD		2.2µF/100V SMD
C208			0.1µF/50V SMD		0.1µF/100V SMD
C209~C210			1µF/50V SMD		
C211~C212			6.8µF/50V SMD		2.2µF/100V SMD
CY10			100pF/Y1		
CY1	Not fitted	100pF/Y1		Not fitted	100pF/Y1
CY2			100pF/Y1		
CY3~CY4			2200pF/Y1		
CY5~CY6			2200pF/Y1		
CY7~CY8			0.022µF/275Vac 10mm X2		
L101~L102			0.72mH 0.8mm*2/10T R-22/14/8B MA100-C ALWIN		
L201	0.12mH 0.7mm*8/2T FC-N0179C WELL LIGHT		0.51mH 0.8mm*4/4T FCNO179C WELL LIGHT		
BEAD CORE			CY5, CY6, BRI 4*1.5*2 CHILISIN (G4058651007)		

Notes:

C101, C102, C105: 1812 X7R ceramic  
 C103, C113: NIPPON CHEMI-CON KXJ series aluminum capacitor  
 C106: Nichicon CS series aluminum capacitor  
 C114: NIPPON CHEMI-CON KXJ series aluminum capacitor  
 C201, C202: 0805 X7R ceramic  
 C203, C204, C211, C212: 1812 X7R ceramic  
 C205, C206, C207, C208, C209, C210: 1206 X7R ceramic  
 CY1, CY2, CY3, CY4, CY5, CY6, CY10: TDK Y1 capacitor or equivalent

CY7, CY8: CARLI MPX Series X2 capacitor  
 L101, L102: 0.72mH 0.8mm\*2/10T R-22/14/8B MA100-C ALWIN (G91CA125615)  
 L201: 0.12mH 0.7mm\*8/2T, FCNO179C WELL LIGHT (G91C7425515)  
 0.51mH 0.8mm\*4/4T, FCNO179C WELL LIGHT (G91C7421915)  
 D101: SMCJ180A, LITTELFUSE  
 D102: STTH8R03DJF-TR ST

Mechanical Details

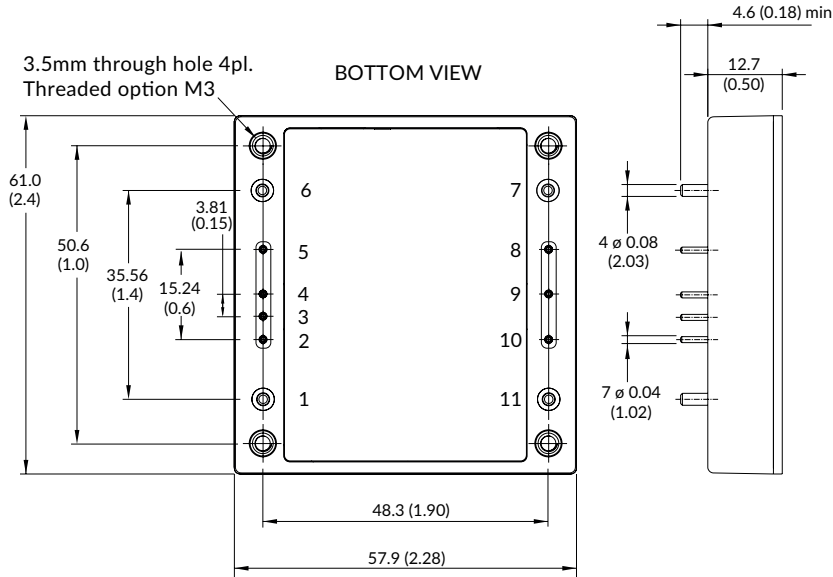

Pin Connections	
Pin	Single
1	+Vin
2	UVLO
3	Sync
4	On/Off
5	BUS
6	-Vin
7	-Vout
8	-Sense
9	Trim
10	+Sense
11	+Vout

Notes:

1. All dimensions are in mm (inches)
2. Weight: 105g (0.23lb) approx.
3. Tolerance: x.xx = x.x = ±0.5 (±0.02), x.xx = ±0.25 (x.xxx = ±0.01)
4. Optional M3 x 0.5 threaded baseplate fixing add suffix -T
5. Mounting holes can be used as functional ground