

20 Watts

- Fully Encapsulated Chassis Mount
- Wide 4:1 Input Range
- -40 °C to +95 °C Operating Temperature
- High Efficiency up to 91 %
- Optional DIN Rail Version
- Remote On/Off
- EN55032 Conducted Level A With No External Components
- 3 Year Warranty



Dimensions:

DTE20:

3.78 x 2.13 x 0.92" (96.0 x 54.0 x 23.3 mm)

Models & Ratings

Input Voltage	Output Voltage	Output Current	Input Current ^(1,4)		Maximum Capacitive Load	Efficiency ⁽²⁾	Model Number ⁽³⁾
			No Load	Full Load			
24 V (9-36 V)	5.1 V	4.0 A	70 mA	0.94 A	6800 µF	90%	DTE2024S5V1
	12.0 V	1.67 A	70 mA	0.92 A	1160 µF	90%	DTE2024S12
	24.0 V	0.835 A	70 mA	0.92 A	300 µF	90%	DTE2024S24
	48.0 V	0.42 A	70 mA	0.94 A	75 µF	89%	DTE2024S48
48 V (18-75 V)	5.1 V	4.0 A	35 mA	0.47 A	6800 µF	89%	DTE2048S5V1
	12.0 V	1.67 A	35 mA	0.46 A	1160 µF	91%	DTE2048S12
	24.0 V	0.835 A	35 mA	0.46 A	300 µF	92%	DTE2048S24
	48.0 V	0.42 A	35 mA	0.47 A	75 µF	90%	DTE2048S48

Notes

1. Input current measured at nominal input voltage.
2. Typical values.
3. For optional version fitted with Din Clip add suffix '-D' e.g. DTE2024S24-D.
4. Input current is typically 3 mA at nominal input voltage when output is remotely turned off.

Mechanical Details

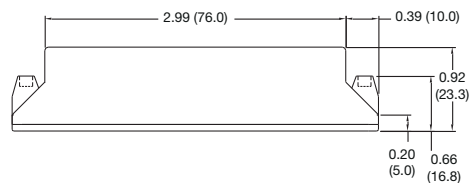
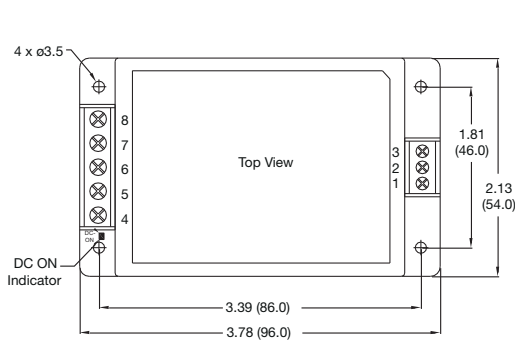

-D Version

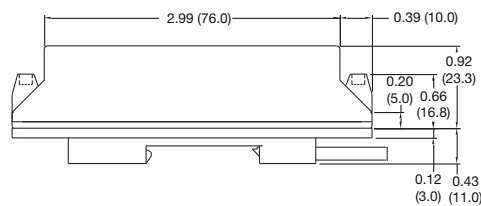

Pin Connections	
Pin	Function
1	Remote On/Off
2	-Vin
3	+Vin
4	No Connection
5	-Vout
6	No Connection
7	+Vout
8	No Connection

Notes

1. All dimensions are in inches (mm)
2. Weight: 0.214 lbs (107 g) approx
3. Weight for -D version: 0.332 lbs (166 g) approx
4. Terminal wire size 1.5 mm² max
5. Screw terminal torque 4.5 to 6.2 lb-in (0.5 to 0.7 Nm)
6. Case tolerance: ±0.02 (±0.5)

Input

Characteristic	Minimum	Typical	Maximum	Units	Notes & Conditions
Input Voltage Range	9		36	VDC	24 V nominal
	18		75	VDC	48 V nominal
Input Current					See Models and Ratings table
Inrush Current				A	
Input Filter	Pi type				
Undervoltage Lockout	On at >9 V. Off <7.5 V				24 V models
	On at >18 V. Off <16.0 V				48 V models
Input Surge			50	VDC	24 V models for 100 ms
			100	VDC	48 V models for 100 ms
Remote On/Off	On: Logic High (3.5-12 V) or open circuit				
	Off: Logic Low (<1.2 V) or short pin 1 to pin 2				

Output

Characteristic	Minimum	Typical	Maximum	Units	Notes & Conditions
Output Voltage	5.1		48	V	See Models and Ratings table
Initial Set Accuracy		±1	±2	%	
Minimum Load	0			A	No minimum load required
Start Up Delay		50		ms	
Line Regulation		±0.5		%	
Load Regulation		1		%	0 - 10% load
Transient Response			5	% deviation	Recovery to within 1% in <250 µs for a 50% load change at 0.25 A/µs rate
Ripple & Noise			100 150 200	mV pk-pk	5.1 V model, 20 MHz bandwidth 12 V & 48 V models, 20 MHz bandwidth 48 V model, 20 MHz bandwidth
Short Circuit Protection					Trip & Restart (hiccup mode), auto recovery
Overload Protection		150		%	Trip & Restart (hiccup mode)
Overvoltage Protection		120		%	Zener diode clamp
Temperature Coefficient			0.02	%/°C	

General

Characteristic	Minimum	Typical	Maximum	Units	Notes & Conditions
Efficiency		90		%	See Models and Ratings table
Isolation	2500			VDC	For 60 s
Isolation Resistance	1000			MΩ	At 500 VDC
Input to Output Capacitance			2200	pF	
Switching Frequency		285		kHz	
Power Density			2.7	W/in ³	
Mean Time Between Failure	750			kHrs	MIL-HDBK-217F, +25 °C GB
Weight		0.214 (107)		lb (g)	

Environmental

Characteristic	Minimum	Typical	Maximum	Units	Notes & Conditions
Operating Temperature	-40		+95	°C	See derating curve
Storage Temperature	-50		+125	°C	
Case Temperature			95	°C	
Thermal Impedance (Case to Ambient)	3.9			°C/W	Natural convection
	3.9				100 LFM
	3.1				200 LFM
	2.5				400 LFM
Humidity	5		95	%RH	Non-condensing
Cooling					Natural convection
Shock	±3 shocks in each plane, total 18 shocks of 30 g : 11 ms halfsine. Conforms to EN60068-2-27 & EN60068-2-47				
Vibration	10-500 Hz at 2 g sweep and endurance at resonance in all 3 planes. Conforms to EN60068-2-6				

EMC: Emissions

Phenomenon	Standard	Test Level	Notes & Conditions
Conducted	EN55032	Level A	With no external components
Radiated	EN55032	Level A	See application notes

EMC: Immunity

Phenomenon	Standard	Test Level	Criteria	Notes & Conditions
Immunity	EN55024			
ESD Immunity	EN61000-4-2	±4 kV Contact, ±8 kV Air	A	
Radiated Immunity	EN61000-4-3	10 V/m	A	
EFT/Burst	EN61000-4-4	3	A	
Surges	EN61000-4-5	3	A	
Conducted Immunity	EN61000-4-6	10 Vm	A	
Magnetic Fields	EN61000-4-8	30 A/m	A	

Safety Approvals

Safety Agency	Safety Standard	Notes & Conditions
CB	IEC60950-1	ITE
UL	UL60950-1	ITE

Application Notes

Derating Curve for Convection Cooling

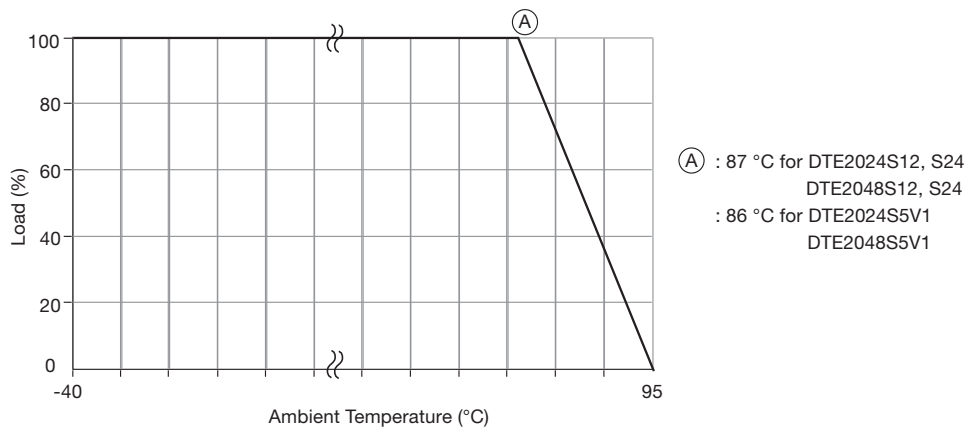

Radiated Emissions

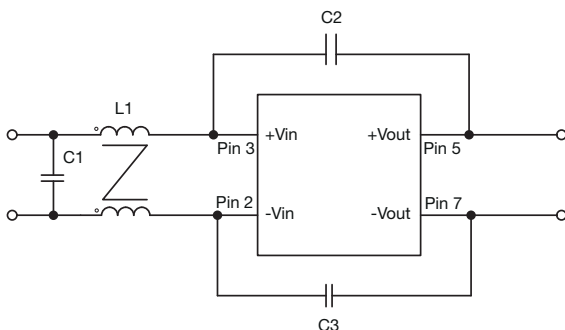

Model	L1	C1	C2	C3
DTE2024SXX	120 μ H	4.7 μ F/50 V	None	220 pF/3 KV
DTE2048SXX	120 μ H	3.3 μ F/100 V	220 pF/3 KV	220 pF/3 KV

Mechanical Details

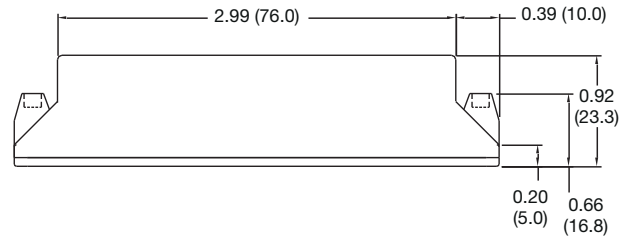
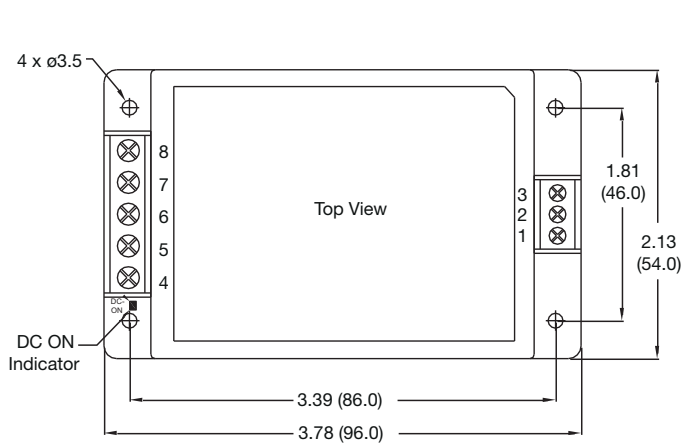

-D Version

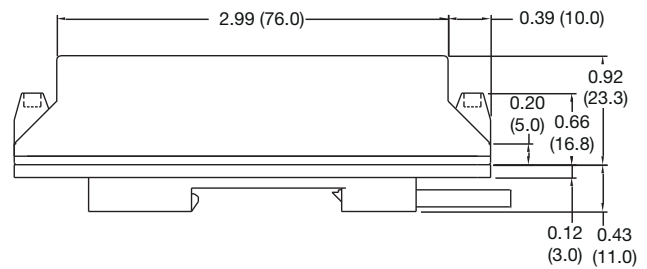

Notes

1. All dimensions are in inches (mm)
2. Weight: 0.214 lbs (107 g) approx
3. Weight for -D version: 0.332 lbs (166 g) approx
4. Terminal wire size 1.5 mm² max
5. Screw terminal torque 4.5 to 6.2 lb-in (0.5 to 0.7 Nm)
6. Case tolerance: ±0.02 (±0.5)

Pin Connections	
Pin	Function
1	Remote On/Off
2	-Vin
3	+Vin
4	No Connection
5	-Vout
6	No Connection
7	+Vout
8	No Connection