

IFC165 Series



- 165 Watt Force Cooled (12 CFM)
- Small Size 3.0" x 5.0" x 1.25"
- Built-In Oring Diodes (Single O/P Models)
- Wide Operating Temperature -25 °C to +70 °C
- Level B Conducted Emissions
- EN61000-3-2, 3 Compliant
- Universal AC Input 90-264 VAC
- Input Frequency 47-63 Hz
- 1-4 Outputs
- Mating Connector & Loom Kits Available

The IFC165 series of multi output AC-DC, 165 Watt power supplies from XP has outputs from 5 VDC to 48 VDC, with single output models offering a 12 V 1A fan supply.

These high density power supplies are available with dual, triple and quad outputs and meet EN55022 Level B EMI/EMC specifications with external filter.

IFC165 power supplies will deliver full power between -25 °C and +50 °C and up to +70 °C with derating and only 12 CFM of cooling. Features include a built in oring diode on single output models.

Comprehensive overvoltage, overload and short circuit protection is built-in, with looms and connector kits available from stock.



T H E X P E R T S I N P O W E R

Input Characteristics

Characteristic	Minimum	Typical	Maximum	Units	Notes & Conditions
Input Voltage - Operating	90		264	VAC	
Input Frequency	47	50/60	63	Hz	
Input Current - No Load			62	mA	At 90 VAC
Input Current - Full Load			2.25	A	At 90 VAC
Inrush Current			66	A	230 VAC
Input Protection					AC Line Fuse
Earth Leakage Current			<750	µA	240 VAC, 50 Hz

All specifications are at nominal input, full resistive load at 25 °C unless otherwise stated.

Output Characteristics

Characteristic	Minimum	Typical	Maximum	Units	Notes & Conditions
Output Voltage	5		48	VDC	Model-dependent
Initial Set Accuracy				%	See Output Tolerance
Output Voltage Adjustment		N/A		%	Not adjustable by user
Minimum Load	5			W	
Start Up Delay	1.5		15	ms	See graph
Start Up Rise Time			20	ms	See graph
Hold Up Time	22			ms	See graph
Output Tolerance			±5	%	5 W min load on any combination of outputs required. Figure quoted is total line, load and initial set accuracy
Transient Response			5	%	Recovering to within 1% in 500 µs for 25% load change
Ripple & Noise			±1	%	
Overvoltage Protection	113	125	145	%	Recycle input to reset
Overload Protection			150	% Vnom	hiccup mode, auto-recovery

Control and Signalling

Characteristic	Notes & Conditions
Remote Sense	Compensates for 0.5 V (Output 1 only)
AC OK	See timing table
Power Good	See timing table

Reliability & Service Life

Characteristic	Typical	Units	Notes & Conditions
MTBF	200,000	Hours	Calculated mean time between failures, per Bellcore

Isolation

Characteristic	Minimum	Typical	Maximum	Units	Notes & Conditions
Input to Output Test Voltage	3000			VAC	Test Duration 1 minute
Input to Ground Test Voltage	1500			VAC	Test Duration 1 minute
Output to Ground Test Voltage	500			VAC	Test Duration 1 minute

Other Specifications

Characteristic	Minimum	Typical	Maximum	Units	Notes & Conditions
Weight		0.57 / 260		lb / g	
Power Density		8.8		W/in ³	

Environmental Requirements

Characteristic	Minimum	Typical	Maximum	Units	Notes & Conditions
Operating Temperature	-25		+70	°C	Derate linearly from 100% load at 50 °C to 50% load at 70 °C
Storage Temperature	-40		+85	°C	
Cooling	12			CFM	Required for full power
Humidity			85	%RH	Non-condensing
Operating Altitude			3000	m	
Vibration			2.4	G	5-500 Hz, 3 axis
Shock			15	G pk	

EMC Electromagnetic Compatibility - Immunity

Phenomenon	Standard	Test Level	Criteria	Notes & Conditions
Harmonic Current	EN61000-3-2	A		
Voltage Flicker	EN61000-3-3	3	B	
EFT	EN61000-4-4	3	B	
Radiated Field	EN61000-4-3	3	B	
Surges	EN61000-4-5	3	B	
Dips & Interruptions	EN61000-4-11	30%, 10 ms 60%, 100 ms 100%, 500 ms	A B B	

EMC Electromagnetic Compatibility - Emissions

Phenomenon	Standard	Test Level	Criteria	Notes & Conditions
Conducted	EN55022/EN60601-1-2	A		Level B with external filter

Standards Compliance List

Standard	Category
EN60950	EN60950-2 : 2001
UL / cUL 60950	UL60950 : 2003 1st Edition
IEC60950	IEC60950 : 2001 1st Edition
CE	LV directive

Safety Agency Approvals

Standard	File Number
UL / cUL 60950	E137895
EN60950	

Model Numbers - Outputs

Model Number	Output 1		Output 2		Output 3		Output 4	
	Vnom	I _{max}	Vnom	I _{max}	Vnom	I _{max}	Vnom	I _{max}
IFC165PS05	+5.0 V	33.0 A	+12.0 V	1.0 A				
IFC165PS12	+12.0 V	13.7 A	+12.0 V	1.0 A				
IFC165PS24	+24.0 V	6.9 A	+12.0 V	1.0 A				
IFC165PS48	+48.0 V	3.4 A	+12.0 V	1.0 A				
IFC165PT31	+5.0 V	21.0 A	+12.0 V	6.0 A	-12.0 V	1.0 A		
IFC165PQ40	+3.3 V	16.0 A	+5.0 V	20.0 A	+12.0 V	6.0 A	-12.0 V	1.0 A

Derating Curves - Efficiency against Output Load

Efficiency against output load 115 VAC input

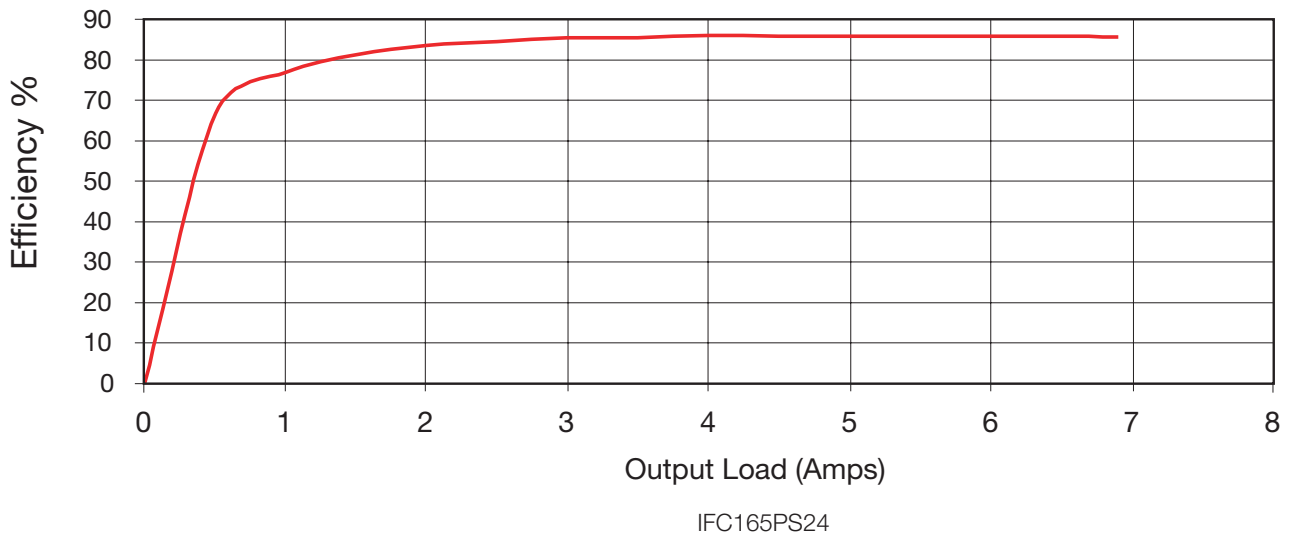

Efficiency against output load 230 VAC input

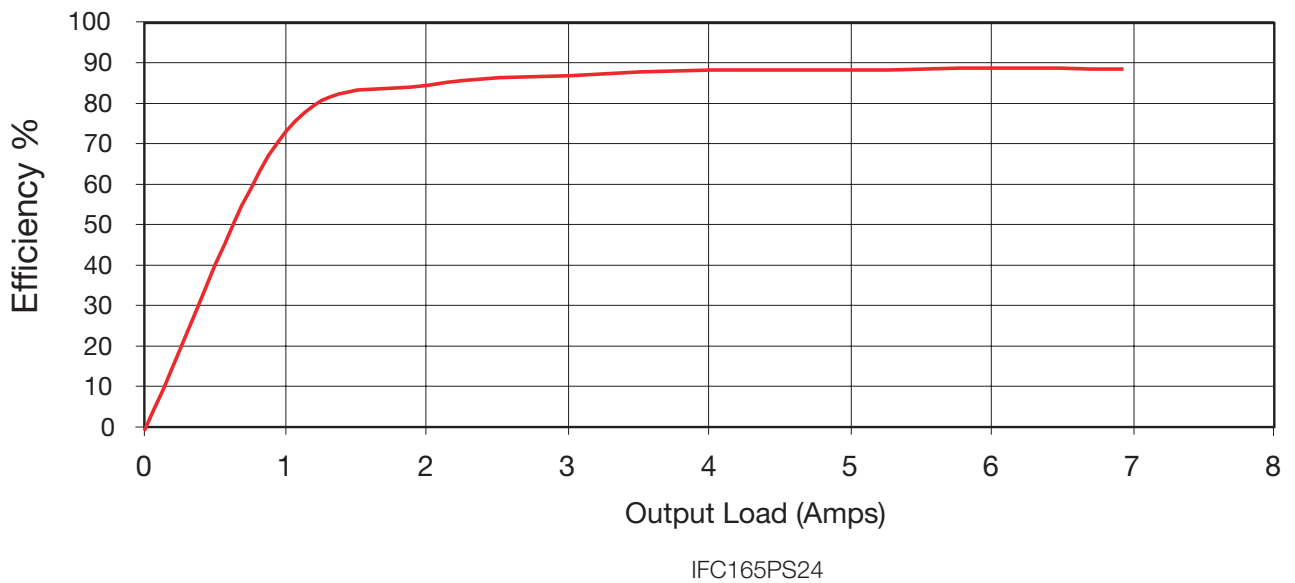

Typical Power Up Characteristics

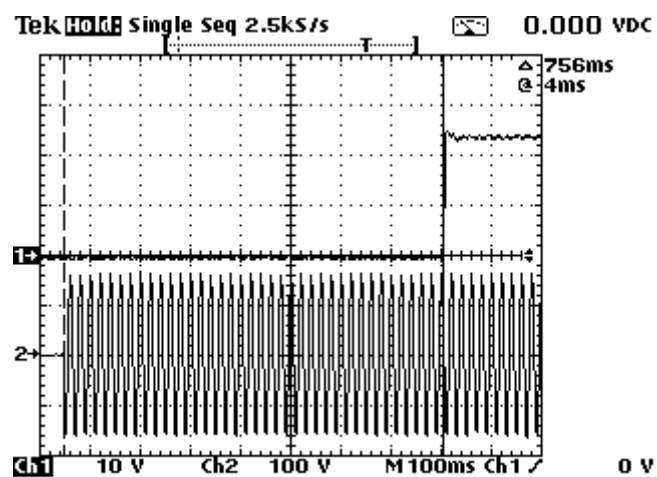

IFC165PS24 Start Up Time 115 VAC

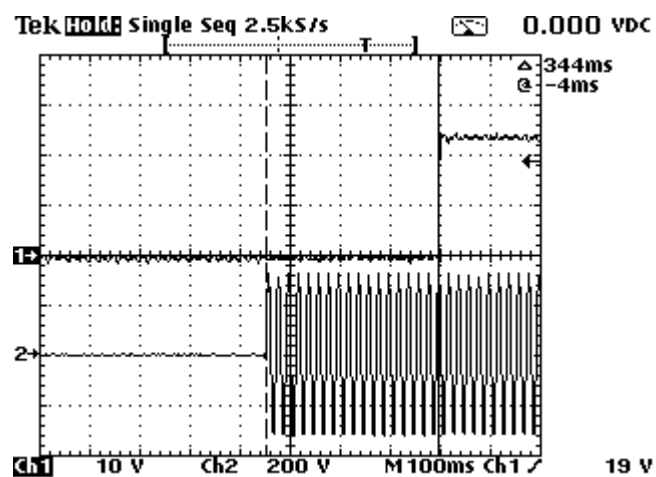

IFC165PS24 Start Up Time 230 VAC

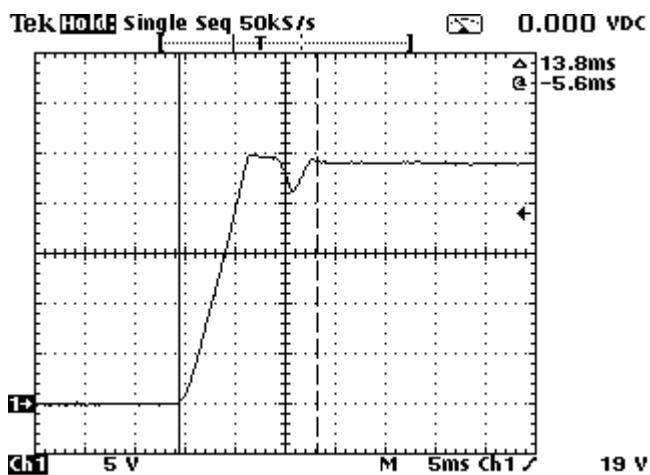

IFC165PS24 Rise Time 115 VAC

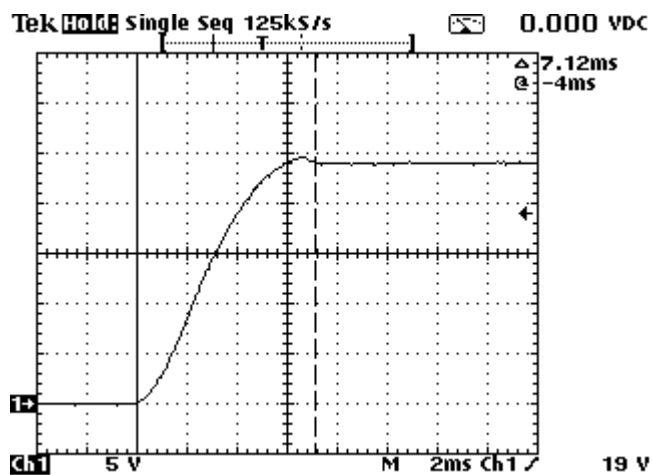

IFC165PS24 Rise Time 230 VAC

Typical Transient Response

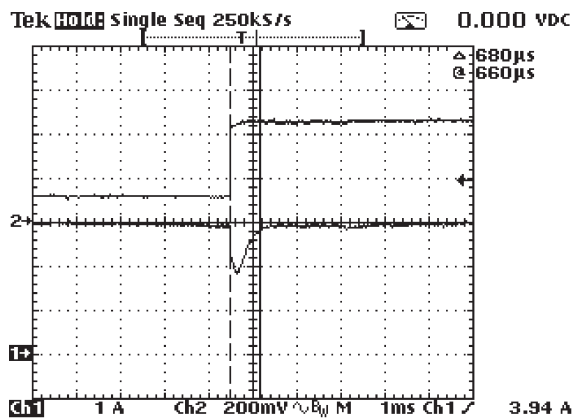

Transient Response - 75-100% load change (24 V Model)

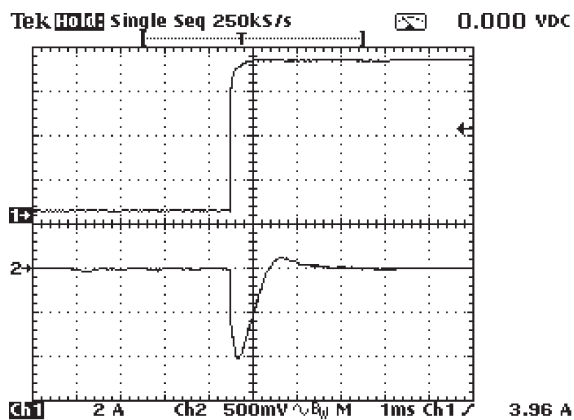

Transient Response - 0-100% load change (24 V Model)

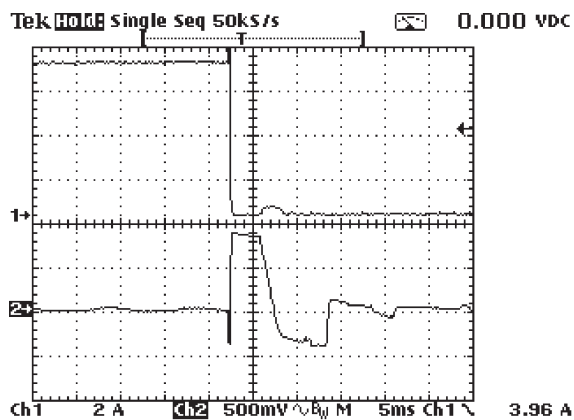

Transient Response - 100-0% load change (24 V Model)

Typical Ripple & Noise

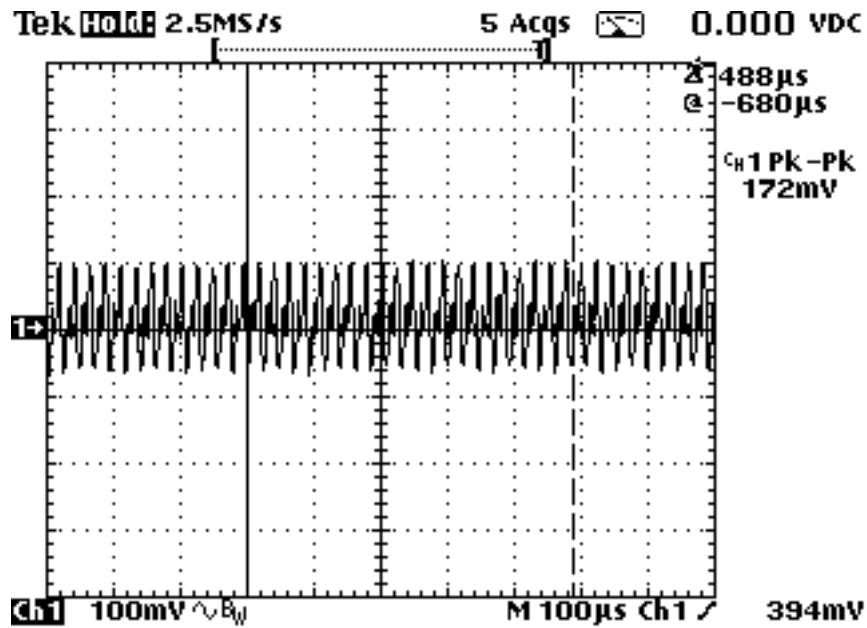

24 V Model

Capacitive Load

The power supply will power up and operate normally with capacitances listed below simultaneously present on the outputs.

Output	Capacitive Load (µF)				
	PT31/ PQ40	PS05	PS12	PS24	PS48
+3.3 V / +2.5 V	6000 µF				
+5 V	10000 µF	10000 µF			
+12 V	1000 µF		4000 µF		
-12 V _{aux}	350 µF	350 µF	350 µF	350 µF	350 µF
15 V					
24 V				2000 µF	
48 V					500 µF

Signal Timing

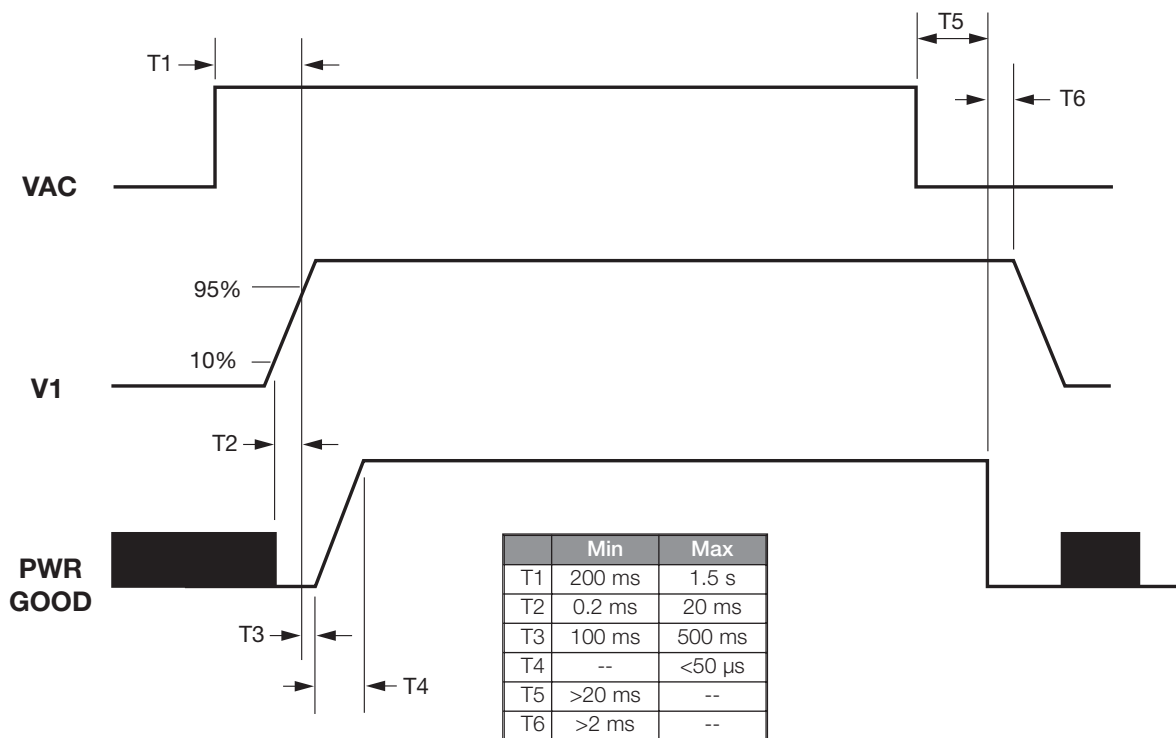

Power Good Signal / PS_OK Signal

The Power Good Signal provides a high logic level to indicate that sufficient time has expired for the DC outputs to be within their regulation limits and that sufficient mains energy is stored by the power supply to ensure continuous power operation within specification for the duration of the hold-up time. When the AC mains power is removed for a period longer than 20ms, the Power Good Signal transitions to a low logic level. The PS_OK signal is the logical complement of the Power Good Signal and both signals are +5VDC TTL-compatible on all units, with the exception of IFC165PQ40 and IFC165PT31 which have an open-collector output requiring a pull-up resistor for TTL compatibility. The electrical specifications for the Power Good and PS_OK outputs are described below:

Signal Type	+5 VDC, TTL Compatible
Low Logic Level	<0.4 V when sinking 4 mA
High Logic Level	Open Collector Output (see next)
Power Good Pull-up Resistor	TTL compatible only on PT31 and PQ40 models
Power On Delay	Between 100 and 500 ms after V1 outputs reaches regulation
Power Down Warning	>2 ms before V1 reaches minimum regulated output
Rise Time	<50 μ s from 10% to 90% point
PS_OK	Logical complement of Power Good Signal. OPen collector output without a Pull-up resistor

Hold Up Time

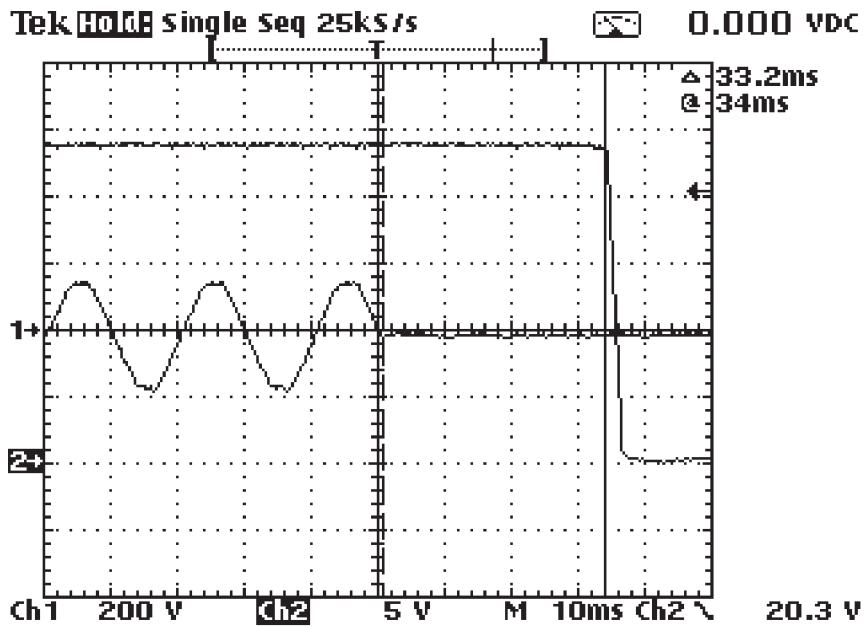

115 VAC

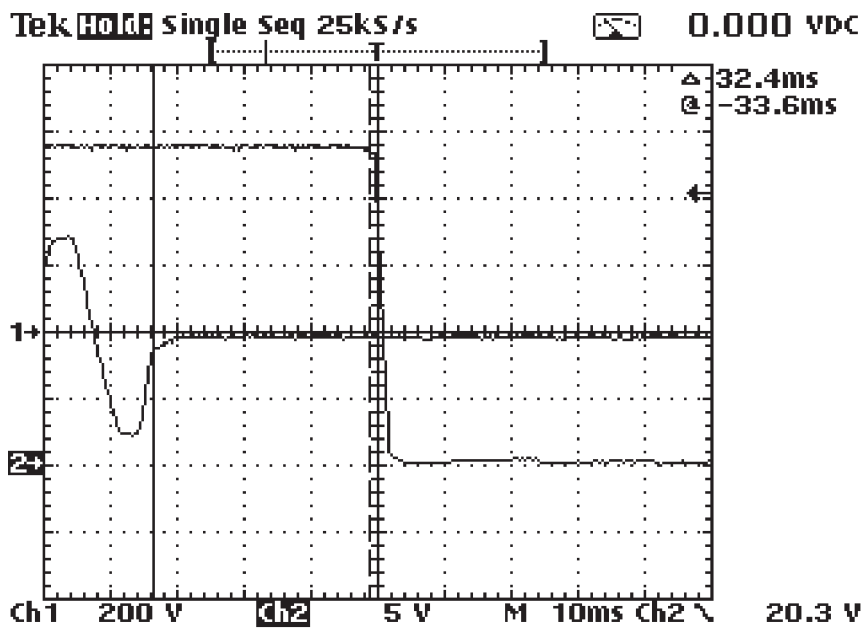

230 VAC

EMC Plots

EN55022 LEVEL A

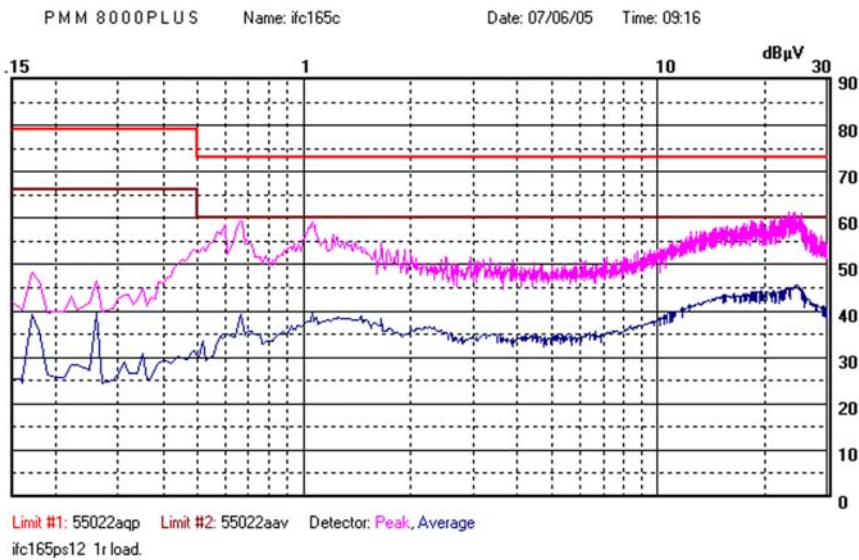

IFC165PS12 Model

EN55022 LEVEL B

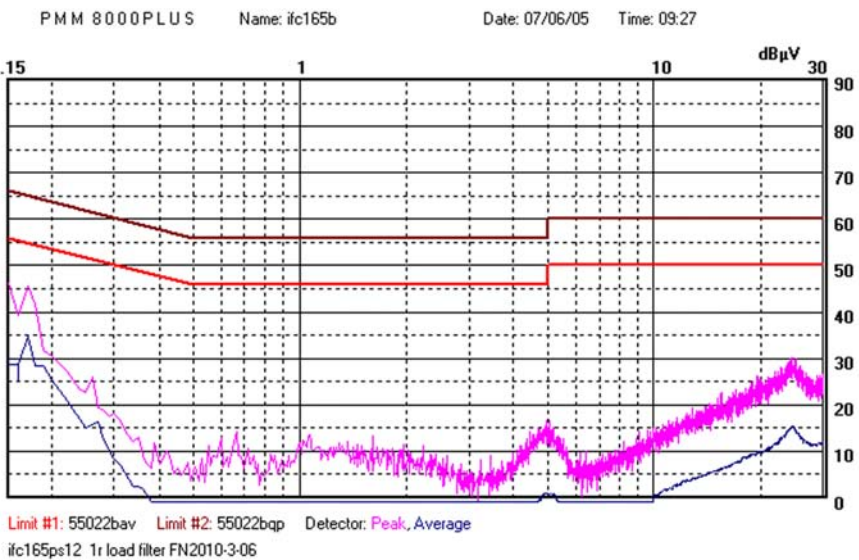

IFC165PS12 Model

Recommended Filters for EN55022 Level B

IFC 165 Model Number	IEC Inlet Filter	Chassis Mount Filter
IFC165PS05	FN9222R-3/06	FN2010-3/06
IFC165PS12	FN9222R-3/06	FN2010-3/06
IFC165PS24	FN9222R-3/06	FN2010-3/06
IFC165PS48	FN9222R-3/06	FN2010-3/06
IFC165PT31	FN321-3/05	FN2020-3/06
IFC165PT40	FN321-3/05	FN2020-3/06

Mechanical Drawings

IFC165PS05 Model

1. All dimensions in inches (mm).
2. Weight 0.57 lb (260 g) approx.
3. The maximum width for the screw head is 0.28 (7.1).
4. #6 or M3 screws recommended.
5. 0.25 inch hex or round stand-offs recommended.

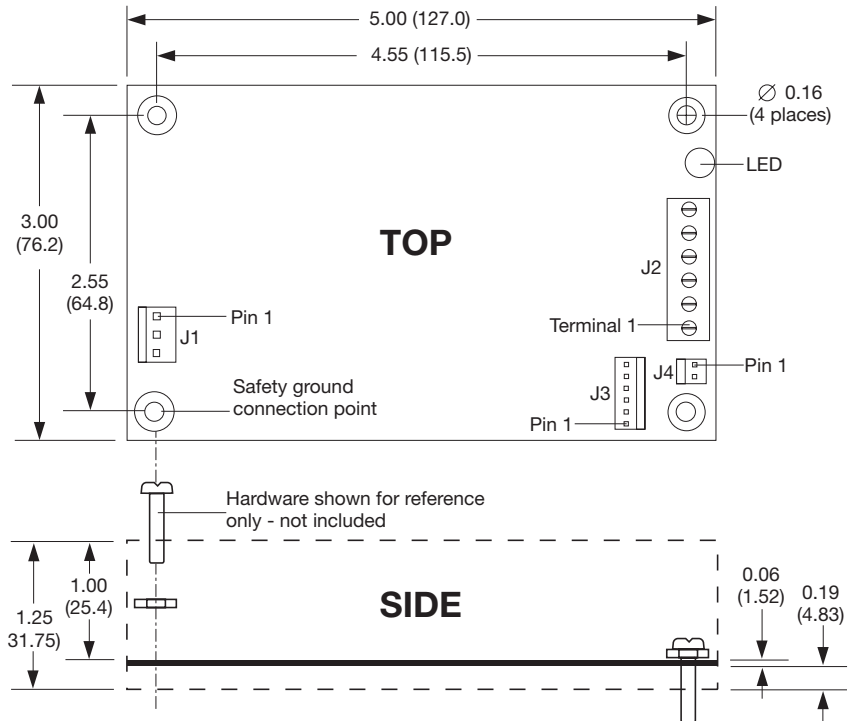

IFC165PS12/24/48 Models

1. All dimensions in inches (mm).
2. Weight 0.57 lb (260 g) approx.
3. The maximum width for the screw head is 0.28 (7.1).
4. #6 or M3 screws recommended.
5. 0.25 inch hex or round stand-offs recommended.

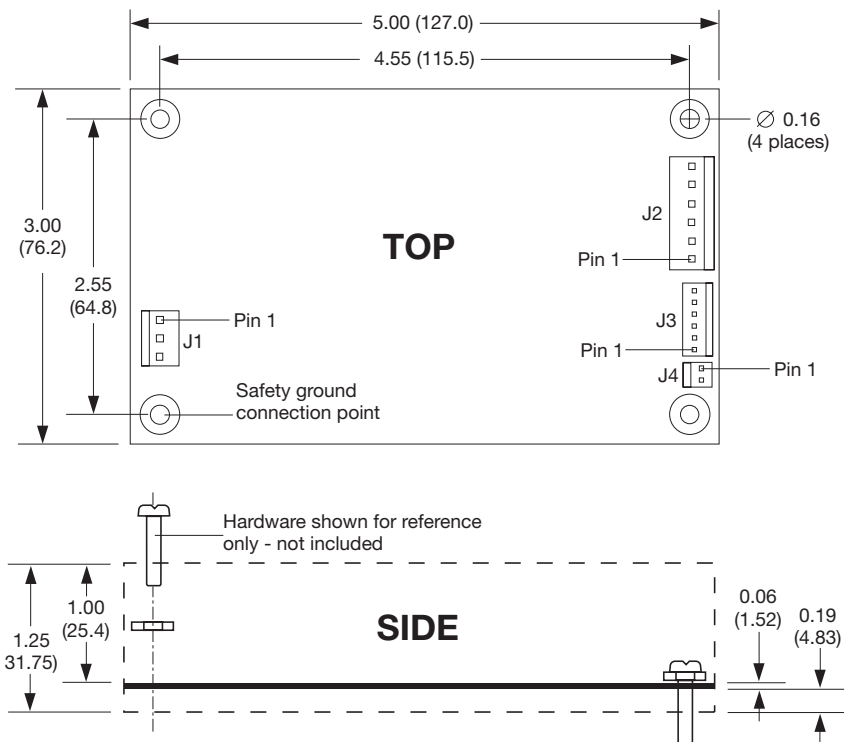

Mechanical Drawings

IFC165PT31/OQ40 Models

1. All dimensions in inches (mm).
2. Weight 0.57 lb (260 g) approx.
3. The maximum width for the screw head is 0.28 (7.1).
4. #6 or M3 screws recommended.
5. 0.25 inch hex or round stand-offs recommended.

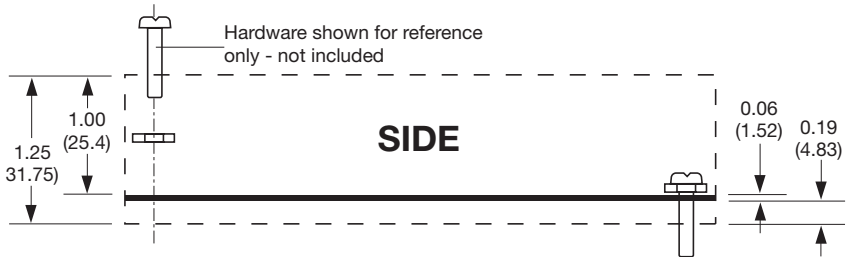
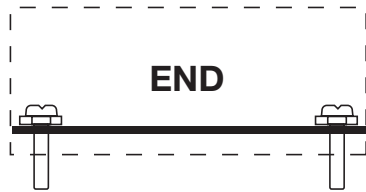
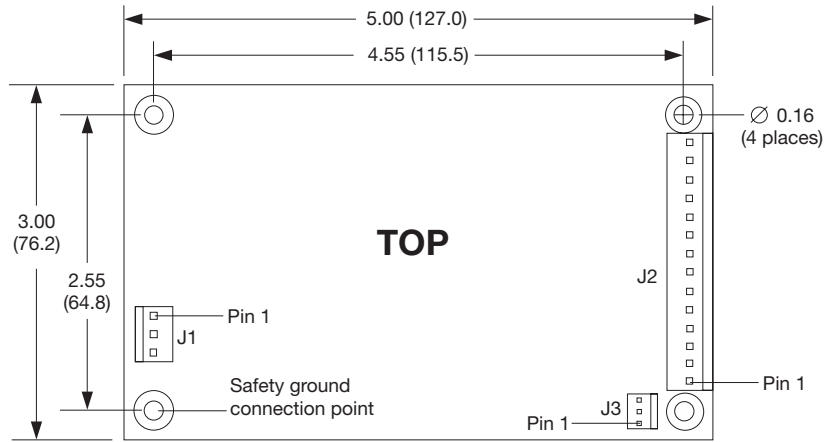

Conn	Pin	Connector Pinouts					
		PS05	PS12	PS24	PS48	PT31	PQ40
J1	1	Neutral	Neutral	Neutral	Neutral	Neutral	Neutral
	2						
	3	Line	Line	Line	Line	Line	Line
J2	1	+5 VDC	+12 V	+24 V	+48 V	-12 V	-12 V
	2	+5 VDC	+12 V	+24 V	+48 V	+12 V	+12 V
	3	+5 VDC	+12 V	+24 V	+48 V	N/A	+3.3 V
	4	RTN	RTN	RTN	RTN	N/A	+3.3 V
	5	RTN	RTN	RTN	RTN	N/A	+3.3 V
	6	RTN	RTN	RTN	RTN	RTN	RTN
J2	7					RTN	RTN
	8					RTN	RTN
	9					RTN	RTN
	10					RTN	RTN
	11					+5 V	+5 V
	12					+5 V	+5 V
	13					+5 V	+5 V
	14					+5 V	+5 V
J3	1	N/C	AC OK	AC OK	AC OK	PG	PG
	2	PS OK	PG	PG	PG	N/A	+3.3 V RS
	3	PG	CS	CS	CS	-R Sense	-R Sense
	4	V1 Sense+	+R Sense	+R Sense	+R Sense		
	5	0V Sense-	-R Sense	-R Sense	-R Sense		
	6	CS	RTN	RTN	RTN		
J4	1	+12 V	+12 V	+12 V	+12 V		
	2	RTN	RTN	RTN	RTN		

Conn	Pin	Mating Connectors		
		PS05	PS12/24/48	PT31 & PQ40
J1	Mating Connector	09-50-8031	09-50-8031	09-50-8031
	Crimp Pins	08-52-0113	08-52-0113	08-52-0113
J2	Mating Connector	Terminal Block	09-50-8061	09-50-8141
	Crimp Pins	N/A	08-52-0113	08-52-0113
J3	Mating Connector	22-01-3057	22-01-3067	22-01-3037
	Crimp Pins	08-50-0114	08-50-0114	08-50-0114
J4	Mating Connector	22-01-3027	22-01-3027	N/A
	Crimp Pins	08-50-0114	08-50-0114	N/A

Notes

Dotted lines for notes

www.xppower.com

North American Sales Offices

Atlanta(678) 474-0268	New Jersey(973) 658-8001	Rochester, N.Y.(585) 272-0250
Austin(512) 248-1140	Northern California(408) 732-7777	San Diego(760) 597-2100
Chicago(630) 980-9890	North Carolina(919) 834-8050	Toronto(905) 278-1060
Colorado(720) 279-2449	Ohio(614) 433-9140	Vancouver, BC(604) 469-8782
Connecticut(860) 633-0717	Orange County(714) 712-4504	Wisconsin(262) 743-1444
Dallas(972) 578-1530	Pacific Northwest(425) 488-5821		
New England(603) 894-4420	Pennsylvania(484) 875-3131		

European Sales Offices

Belgium+31 183 645000	Norway63 89 49 20
Denmark43 42 38 33	Sweden08 555 367 00
France0820 801 401	Switzerland056 483 34 00
Germany0421 63933-0	United Kingdom0118 984 5515
Netherlands0183 645000		

Distributors

Austria022 823 1440	Vitecom	Poland0 22 8178 022	Euro Elektronica
Czech Republic235 366 129	Vums	Portugal+351 21 8484542	Digicontrôle
Finland09 2906 1990	Cool Power	Russia952 340 636	Prosoft
Israel09 741 7277	Tritech	South Africa011 453 1910	Vepac
Italy039 2876 027	Mieltec	Turkey0 312 417 0716	Bupat

North American HQ

XP Power
990 Benecia Avenue
Sunnyvale, CA 94085
Phone : +1 408 732-7777
Fax : +1 408 732-2002
Email : nasales@xppower.com

European HQ

XP Power
Horseshoe Park
Pangbourne
Berkshire, RG8 7JW
Phone : +44 (0)118 984 5515
Fax : +44 (0)118 984 3423
Email : eusales@xppower.com

Asian HQ

XP Power
629 Aljunied Road
#04-08 Cititech Industrial Building
389838
Singapore
Phone : +65 68469368
Fax : +65 67418730
Email : apsales@xppower.com



T H E X P E R T S I N P O W E R